

# Connection diagrams

Lambdamat  
Turbomat



## **Valued Froling Partner!**

At Froling, we want to deliver those environmentally friendly, economical and user-friendly energy system solutions that people want.

This brochure presents the most popular models in our range and offers guidelines for the design and implementation of heating systems.

Please note that not all of the control engineering add-ons can be used with one another.

The systems included are merely examples to illustrate the technical principles. They are no substitute for full system planning.

We reserve the right to make technical changes without prior notice.

If you need more technical information, our customer service department, and of course our internal technical department, will be happy to assist.

Froling GmbH

For general connection options on the H3000 controller for sensors and other connections, please refer to the wiring diagram.

This is supplied with every system.

Circuit diagram	Sensor 1	Sensor 2	Sensor 3
<b>Circuit diagram 1</b>	Sensor for domestic hot water tank	Sensor for return temperature control with mixer	Not in use
<b>Circuit diagram 2</b>	Sensor for upper storage tank temperature	Sensor for lower storage tank temperature	Sensor for return temperature control with mixer

**To ensure an optimum boiler control response, a constant flow rate in the boiler is essential (constant boiler pump speed).**

**The required flow rate is determined by the potential temperature differences on the load side. In order to configure the system parameter settings, the commissioning technician needs to know the actual flow rate through the boiler. This must be determined and made available by the designer for the commissioning process. Incorrect or inaccurate data could affect the control response of the boiler.**

## Requirements for water supplies

There are no special requirements for the water used to fill the heating system. However, the following standards and guidelines apply::

- Austria: ÖNORM H 5195-1
- Germany: VDI 2035
- Switzerland: SWKI 97-1
- Italy: D.P.R. no. 412

Note on filling with make-up water:

Bleed the filling hose before connecting to prevent air from getting into the system.

## Heating circuit control

A maximum of two weather-compensated heating circuits can be controlled. This requires a heating circuit board and heating circuit flow sensor. One room sensor can also be connected per heating circuit if required.

## Oil boiler enable

The oil boiler enable is achieved by closing the burner relay, which then controls an oil or gas boiler. The oil/gas boiler can be used for a variety of purposes:

- Peak load coverage if the output from the biomass boiler is no longer sufficient
- Emergency/backup boiler in the event of a fault on the biomass boiler
- Indirect starting aid for the overall system

# Functional description

## Return temperature control with mixer

As a general rule the return temperature control with mixer should be used in all large-scale boiler systems. If the return temperature control is designed in this way, all necessary components are installed in the biomass boiler control panel. However, the mixer and pump must be provided by the customer.

## Buffer tank management (2-sensor management)

Two-sensor management controls the boiler in accordance with a defined start/stop temperature. If the upper buffer temperature (Buffer upper min. temp. parameter) drops below the preset value within the predefined time window, the boiler is started. In buffer mode there are two time windows available. If the boiler is operating at full output, the buffer tank is supplied with heat until the preset buffer lower temperature is reached and the buffer upper temperature is exceeded by the buffer hysteresis setting. If the predefined time window ends during heating-up or heating, the boiler follows the shutdown procedure and stops the supply of heat to the system, regardless of buffer charge. The boiler is only restarted when the release window is reached and the buffer upper temperature falls below the preset minimum value.

Two-sensor buffer tank management is only active in "transitional operation". In "winter operation" the boiler is controlled in accordance with the boiler target temperature only, and the buffer is ignored.

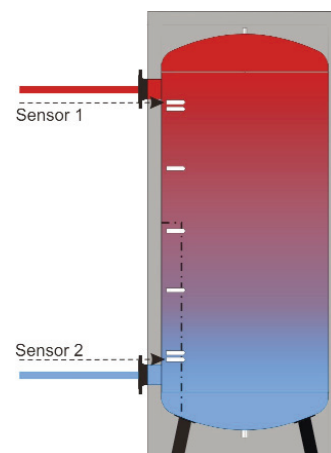

## Five-sensor thermal store management

(only in conjunction with two-sensor management)

In addition to two-sensor storage tank management, in this case five (or more) sensors are distributed evenly over the entire height of the thermal store. The sensors are evaluated by an add-on module. The evaluated signal is sent to the boiler in the form of a 0 to 10 V signal, which is processed by the boiler to a power output of 0 to 100%. The advantage of this system is that the boiler is adjusted accurately to the system requirements and can also respond quickly. The requirement for using five-sensor thermal store tank management is a sufficiently large thermal store (i.e. rather than a basic buffer, and ideally 25 l/kW) and a Froling-approved hydraulic diagram, so that the system does not start to hunt, always has an adequate energy supply and that the boiler can establish a steady operating state. As this additional control is weather-compensated (according to the outside air temperature), a heating circuit board is essential for the use of five-sensor thermal store management.

Five-sensor storage tank management is only active in "transitional operation". In "winter operation" the boiler is controlled in accordance with the boiler set temperature only, and the thermal store status is ignored.

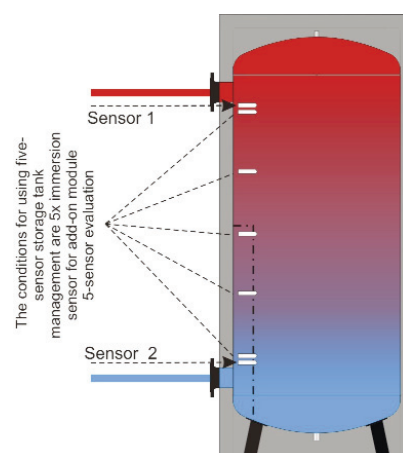

## External load management (DDC power)

External load management is intended for DDC (BMS) control, which reduces the boiler output by means of a 0 to 10 V signal. The 0 V signal corresponds to 0% and the 10 V signal to 100% control of the boiler. If however the master control system sends an inverted signal, this signal can also be used by switching a parameter.

If the boiler receives a start request, the DDC signal is ignored until the "Heating" operating status is achieved. In the "Heating" operating status the boiler is monitored by means of the flue gas temperature. When the boiler reaches the "100% power at ex gas temp." parameter, the system switches to the DDC signal - which can reduce but not increase the boiler power output over its internal temperature based value. From this point onwards the boiler is controlled externally until the next heating-up operation.

Control of the boiler with the power signal is only possible in transitional operation, as this signal is ignored in winter operation.

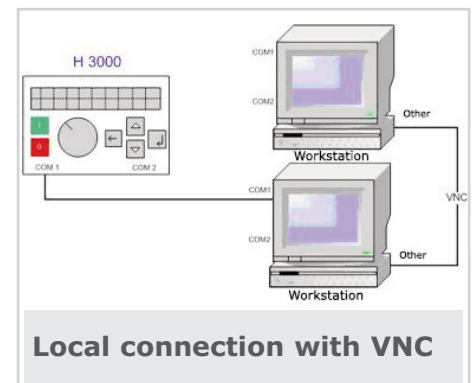
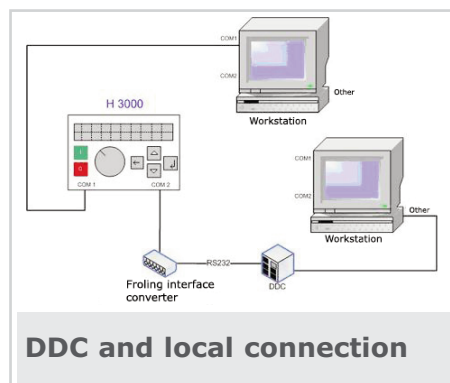
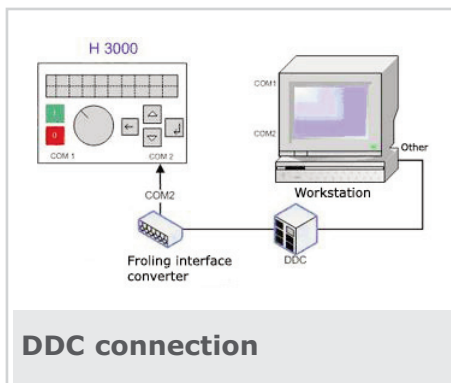

As the same input is used in the controller for each additional control, it is not possible to use both five-sensor thermal store management and external load management at the same time. (Digital inputs or manual switches can be used to switch between these signals).

# Boiler views

## Turbomat 150 / 220

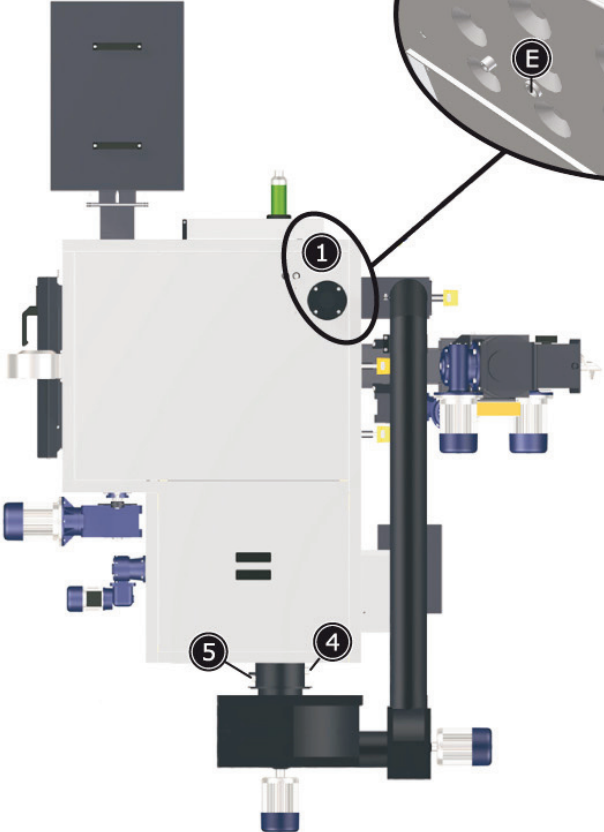
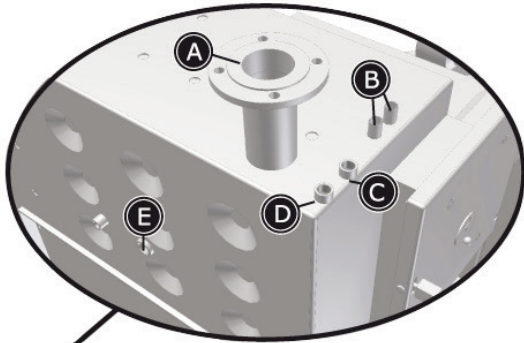
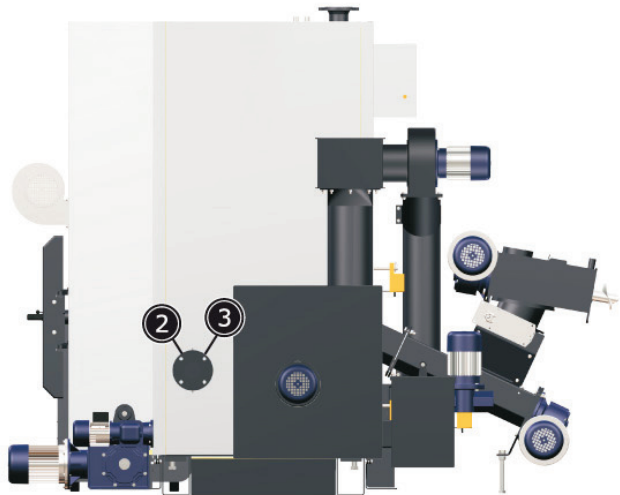

No.	Designation
1A	Flow flange
1B	Emergency cooling coil connection
1C	Immersion sleeve for emergency cooling coil valve
1D	Hi-limit thermostat (STL) / boiler temp. sensor
1E	Combustion chamber temperature sensor
2	Return flange
3	Return sensor (clamp-on sensor)
4	Lambda probe
5	Flue gas temp. sensor

## Connection of water-cooled stoker channel TM 220 (schematic diagram)

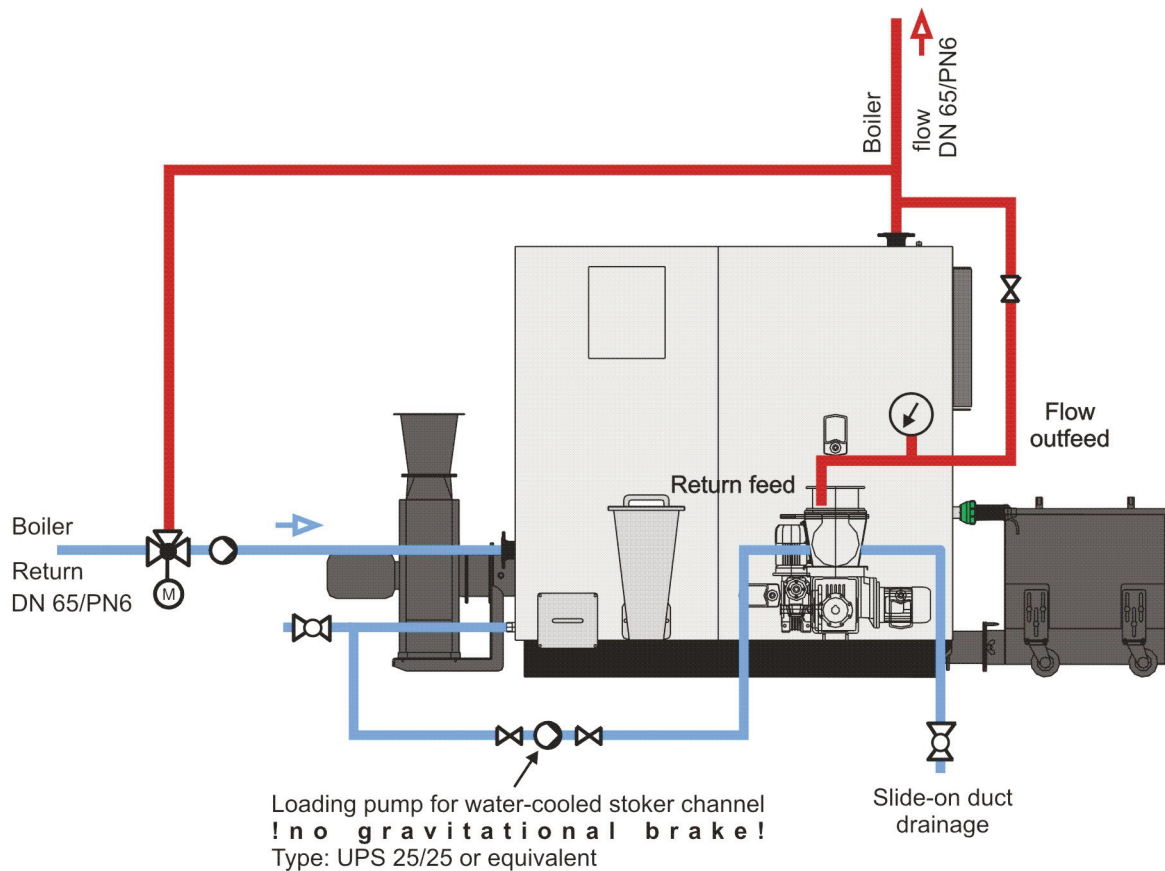

# Boiler views

## Turbomat 320 / 500

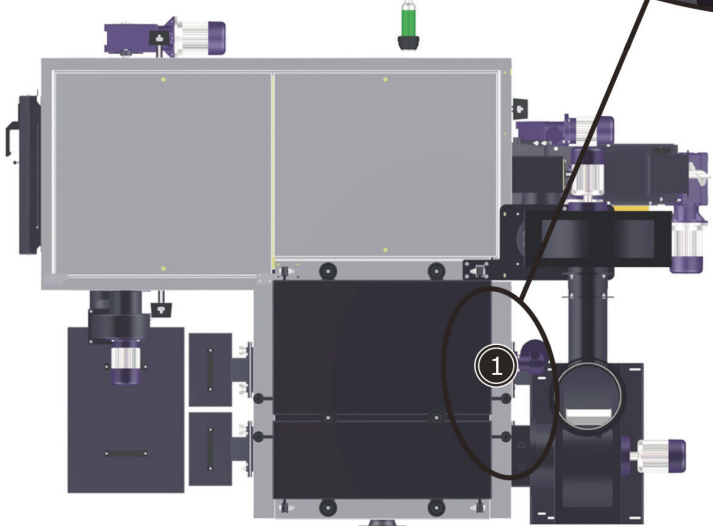
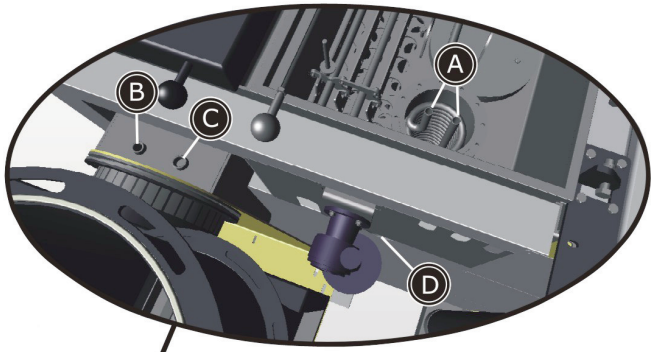
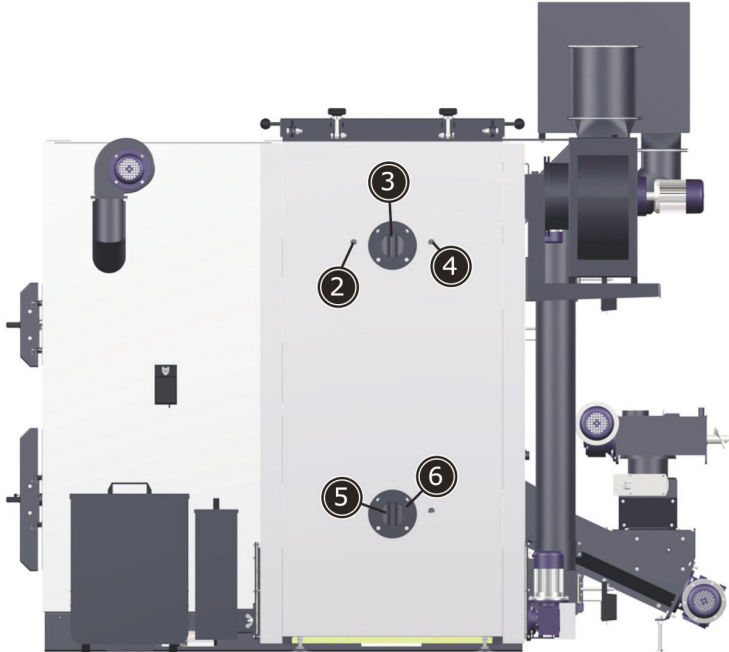



No.	Designation
1A	Emergency cooling coil connection
1B	Lambda probe
1C	Flue gas temp. sensor
1D	Pocket for emergency cooling coil valve
1E	Emergency cooling coil air vent
2	Boiler temp. sensor
3	Flow flange
4	Hi-limit thermostat (STL)
5	Return flange
6	Return sensor (immersion sensor)

## Connection of water-cooled stoker channel (schematic diagram)

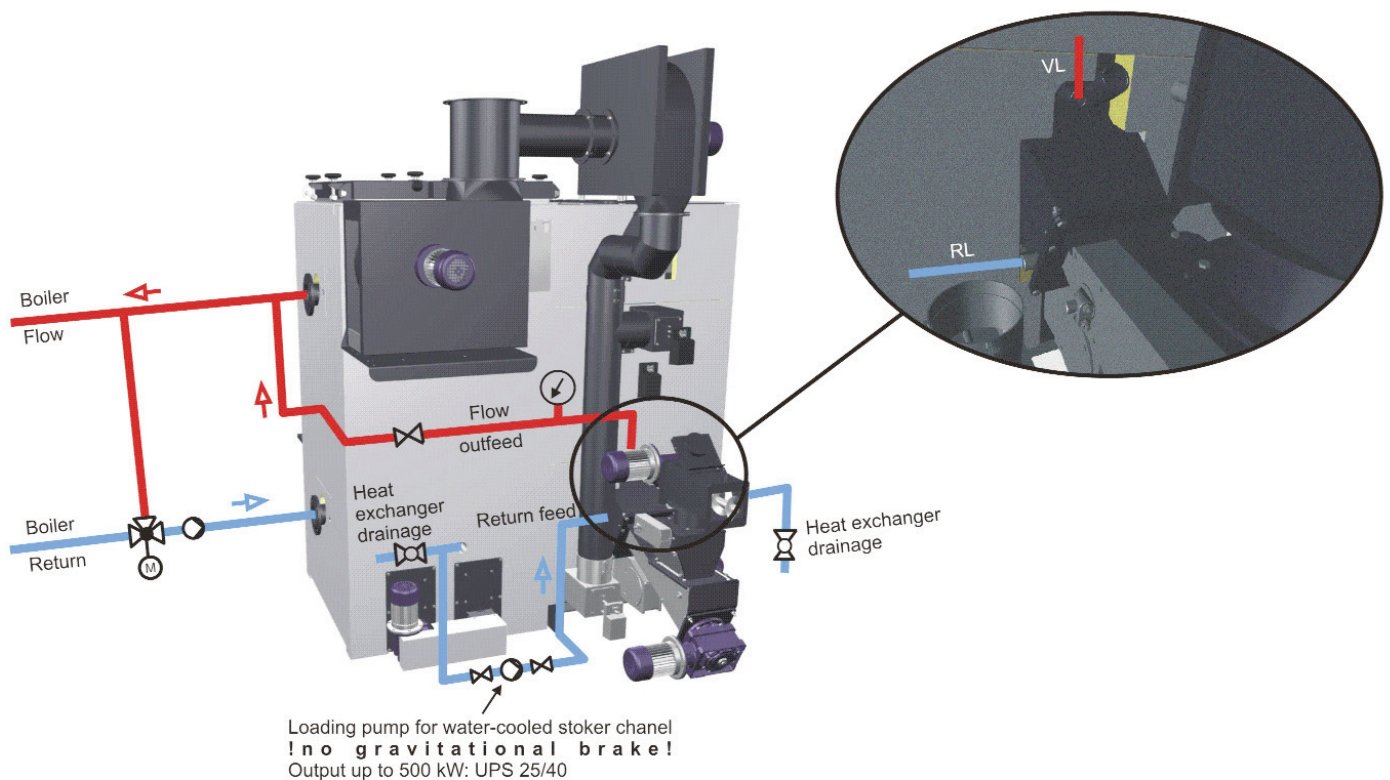

# Boiler views

## Lambdamat 320 / 1000 Kom

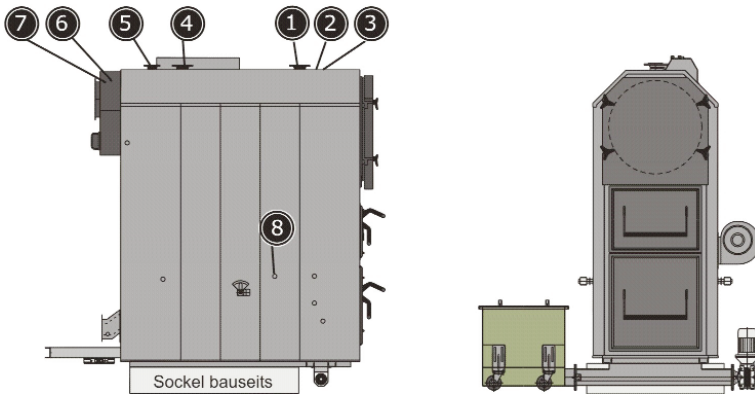

No.	Designation
1	Flow flange
2	Hi-limit thermostat (STL)
3	Boiler temp. sensor
4	Return flange
5	Safety valve
6	Lambda probe
7	Flue gas temp. sensor
8	Combustion chamber temp. sensor

## Connection of water-cooled stoker channel

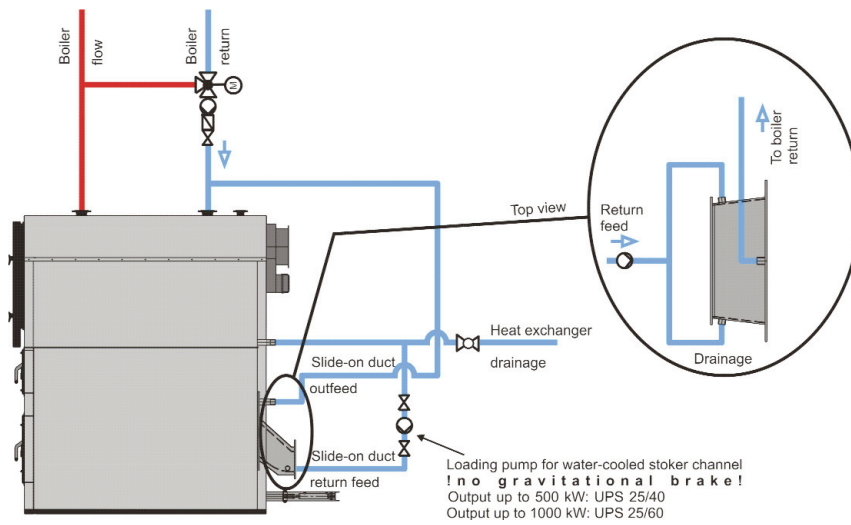

## Connection of emergency cooling coil

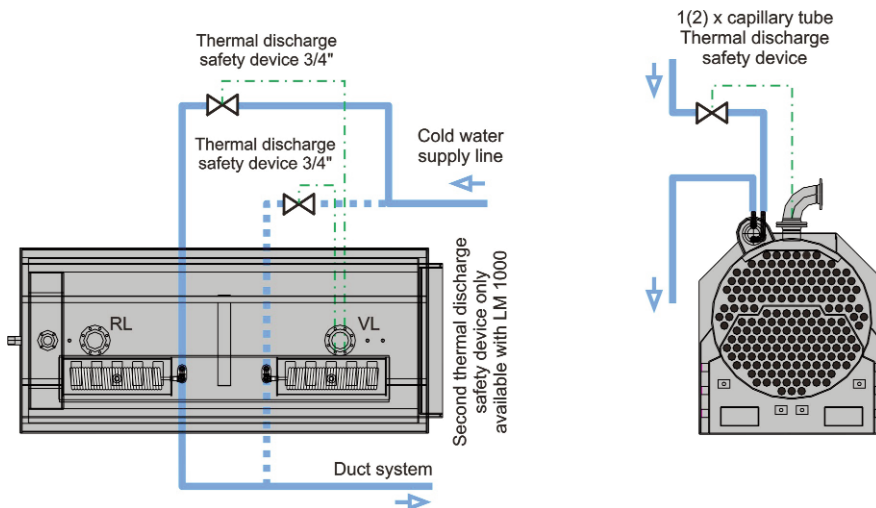

## Lambdamat / Turbomat technical specifications

<b>Lambdamat Industrie</b>		<b>150</b>	<b>220</b>	<b>320</b>	<b>500</b>	<b>750</b>
Max. allowable working pressure	bar	4	4	4	4	4
Max. permitted temperature	°C	110	110	110	110	110
Max. permitted operating temperature	°C	95	95	95	95	95
Minimum return temperature	°C	65	65	65	65	65
Flow rate at dT = 20K	m <sup>3</sup> /h	6,44	9,45	13,78	21,49	32,24
Flow rate at dT = 15K	m <sup>3</sup> /h	8,60	12,61	18,34	28,66	42,99
Water-side resistance at dT = 20K	mbar	14	15	18	15	15
Boiler water capacity	Litres	440	850	760	1060	1740
Flow / return connection - heat exchanger	DN/PN6	65	100	100	100	100
Safety valve connection	DN/PN6	32	50	50	50	65
Inlet / outlet connections - emergency cooling coil		3/4" ET	3/4" ET	3/4" ET	3/4" ET	3/4" ET
<b>Lambdamat Kommunal</b>		<b>320</b>	<b>500</b>	<b>750</b>	<b>1000</b>	
Max. allowable working pressure	bar	4	4	4	4	
Max. permitted temperature	°C	110	110	110	110	
Max. permitted operating temperature	°C	95	95	95	95	
Minimum return temperature	°C	65	65	65	65	
Flow rate at dT = 20K	m <sup>3</sup> /h	13,78	21,49	32,24	42,99	
Flow rate at dT = 15K	m <sup>3</sup> /h	18,34	28,66	42,99	57,32	
Water-side resistance at dT = 20K	mbar	18	15	15	27	
Boiler water capacity	Litres	790	1100	1840	2390	
Flow / return connection - heat exchanger	DN/PN6	100	100	100	125	
Safety valve connection	DN/PN6	50	50	65	65	
Inlet / outlet connections - emergency cooling coil		3/4" ET	3/4" ET	3/4" ET	3/4" ET	
<b>Turbomat Kommunal</b>		<b>150</b>	<b>220</b>	<b>320</b>	<b>500</b>	
Max. allowable working pressure	bar	3	3	6	6	
Max. permitted temperature	°C	110	110	110	110	
Max. permitted operating temperature	°C	95	95	95	95	
Minimum return temperature	°C	65	65	65	65	
Flow rate at dT = 20K	m <sup>3</sup> /h	6,44	9,45	13,78	21,49	
Flow rate at dT = 15K	m <sup>3</sup> /h	8,60	12,61	18,34	28,66	
Water-side resistance at dT = 20K	mbar	15,6	15	18	15	
Heat exchanger water capacity	Litres	440	570	560	750	
Flow / return connection - heat exchanger		DN65/PN6	DN65/PN6	DN100/PN6	DN100/PN6	
Inlet / outlet connections - emergency cooling coil		1/2" IT	1/2" IT	3/4" ET	3/4" ET	
Drainage / stoker channel cooling		3/4"	3/4"	1"	1"	

# Safety equipment

## Safety equipment as per DIN EN 12828 up to 300 kW (regarded as best practice)

The following illustration shows a typical system setup for a direct heating system, operating temperatures up to 95°C, 100°C hi-limit thermostat and a boiler output of up to max. 300 kW.

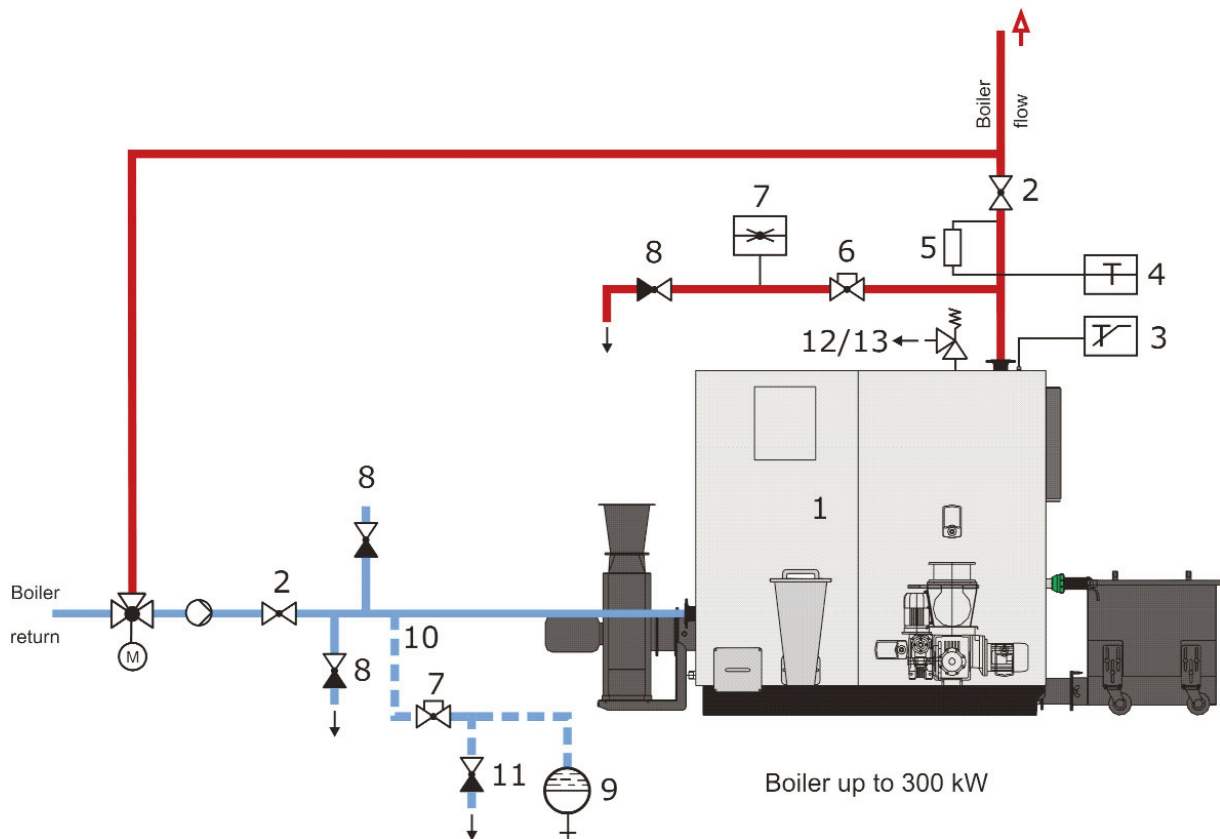

### No. Designation

- |    |   |
|----|---|
| 1  | Boiler  |
| 2  | Flow/return isolating valve   |
| 3  | Hi-limit thermostat (STL), included in delivery   |
| 4  | Temperature gauge   |
| 5  | Low water float switch (WMS)<br>not necessary if a minimum pressure limiter or flow monitor is fitted on each boiler instead.<br>Proof by the boiler manufacturer that no water shortage safety device is necessary is acceptable as an alternative |
| 6  | Lockable isolating valve  |
| 7  | High pressure switch  |
| 8  | Boiler filling and drainage system (KFE)  |
| 9  | Diaphragm expansion tank (MAG) (as per DIN EN 13831)  |
| 10 | Expansion pipe  |
| 11 | Drainage ahead of MAG   |
| 12 | Diaphragm safety valve (MSV) 2.5 / 3.0 bar or   |
| 13 | Lifting spring safety valve (HFS) $\geq$ 2.5 bar  |

## Safety equipment as per DIN EN 12828 above 300 kW

The following illustration shows a typical system setup for a direct heating system, operating temperatures up to 95°C, 100°C high limit thermostat and a boiler output of 300 kW or more.

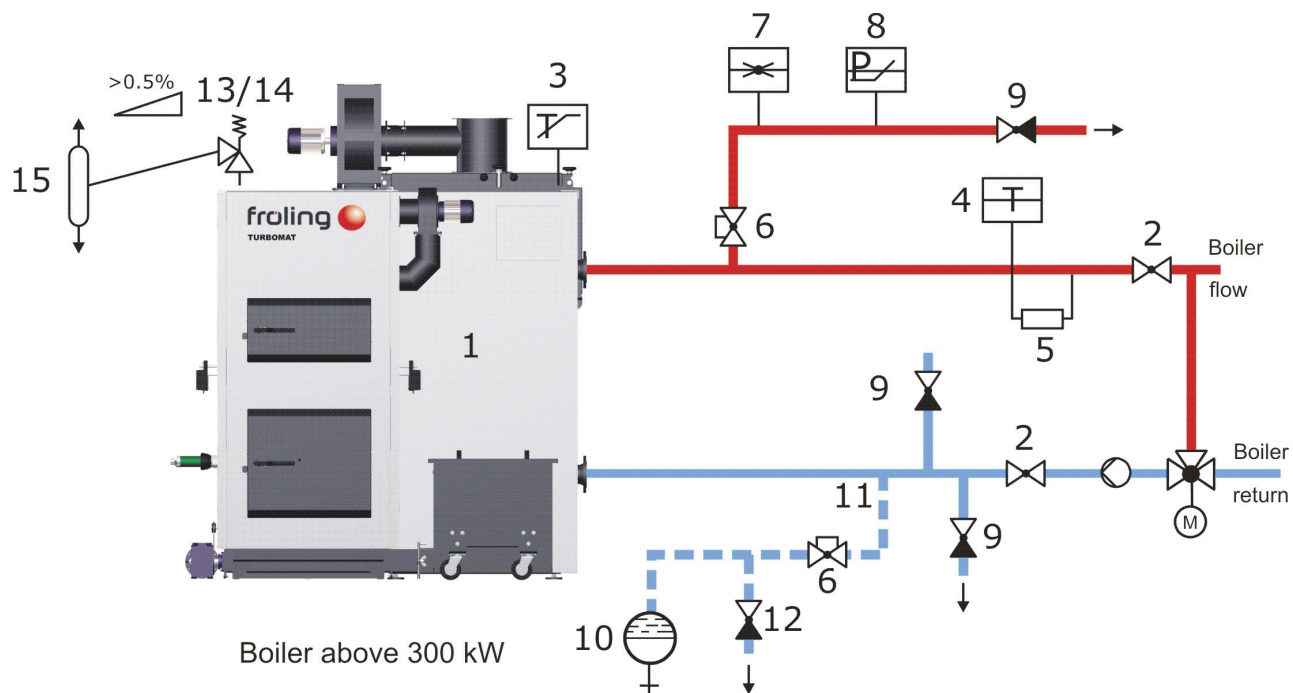

No.	Designation
1	Boiler
2	Flow/return isolating valves
3	High limit thermostat (STL), included in standard delivery
4	Temperature gauge
5	Low water float switch (WMS) not necessary if a minimum pressure limiter or flow monitor is fitted on each boiler instead. Proof by the boiler manufacturer that no water shortage safety device is necessary is acceptable as an alternative
6	Lockable isolating valve
7	High pressure switch
8	Maximum pressure switch
9	Boiler filling and drainage system (KFE)
10	Diaphragm expansion tank (MAG) (as per DIN EN 13831)
11	Expansion pipe
12	Drainage ahead of MAG
13	Diaphragm safety valve (MSV) 2.5 / 3.0 bar or
14	Lifting spring safety valve (HFS) $\geq 2.5$ bar
15	Blowdown vessel (ET)

# Recommended hydraulic layouts

Diagram 1: Turbomat with low-loss header

System 1.0

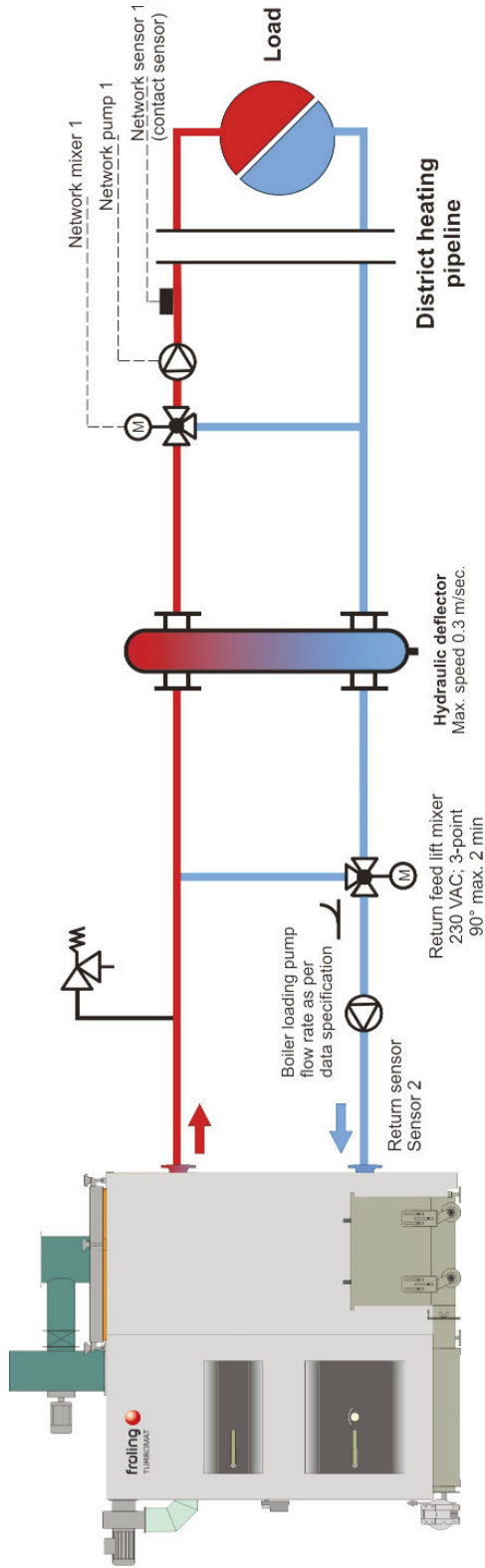

**FRÖLING TURBOMAT**  
wood chip burner  
with control: Lambdatronic H3000

**IMPORTANT:** Using a hydraulic deflector instead of a storage tank requires continuous and constant/slightly variable power consumption!

Diagram 1: Turbomat with low-loss header and DHW tank

System 1.1

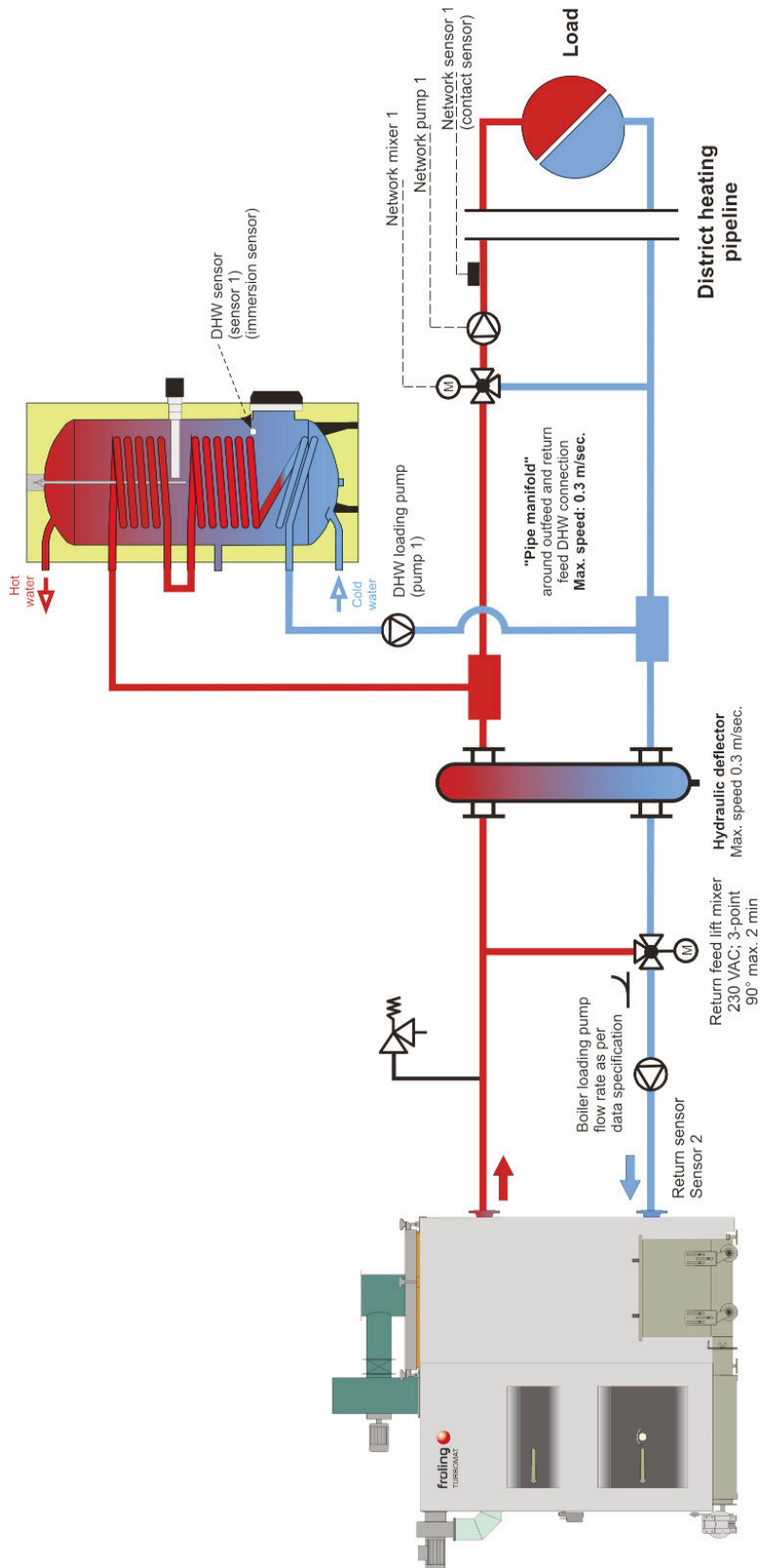

**FRÖLING TURBOMAT**  
wood chip burner  
with control: Lambdatronic H3000

**IMPORTANT:** Using a hydraulic deflector instead of a storage tank requires continuous and constant/slightly variable power consumption!

# Recommended hydraulic layouts

Diagram 1: Turbomat double boiler system with low-loss header

System 1.2

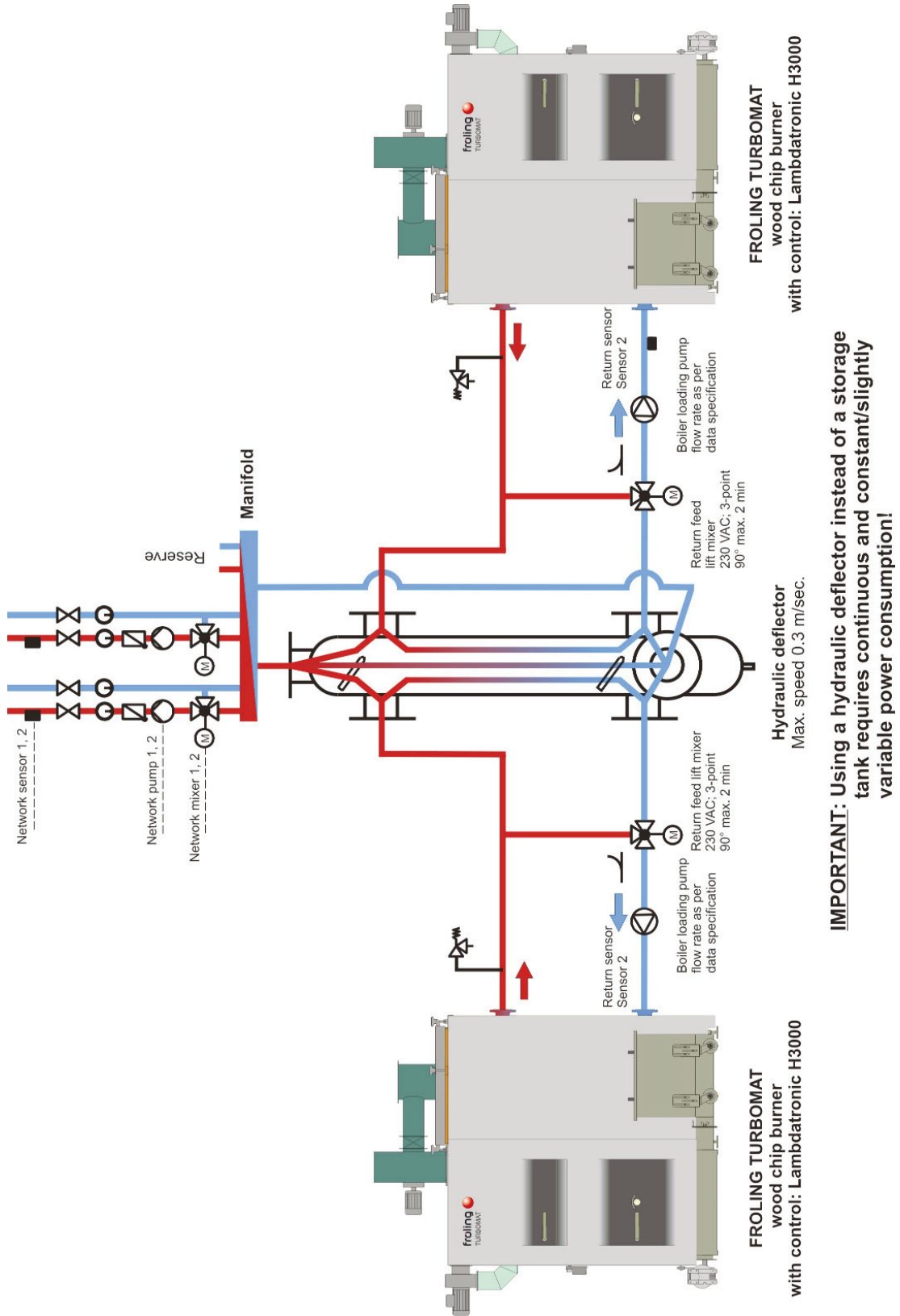
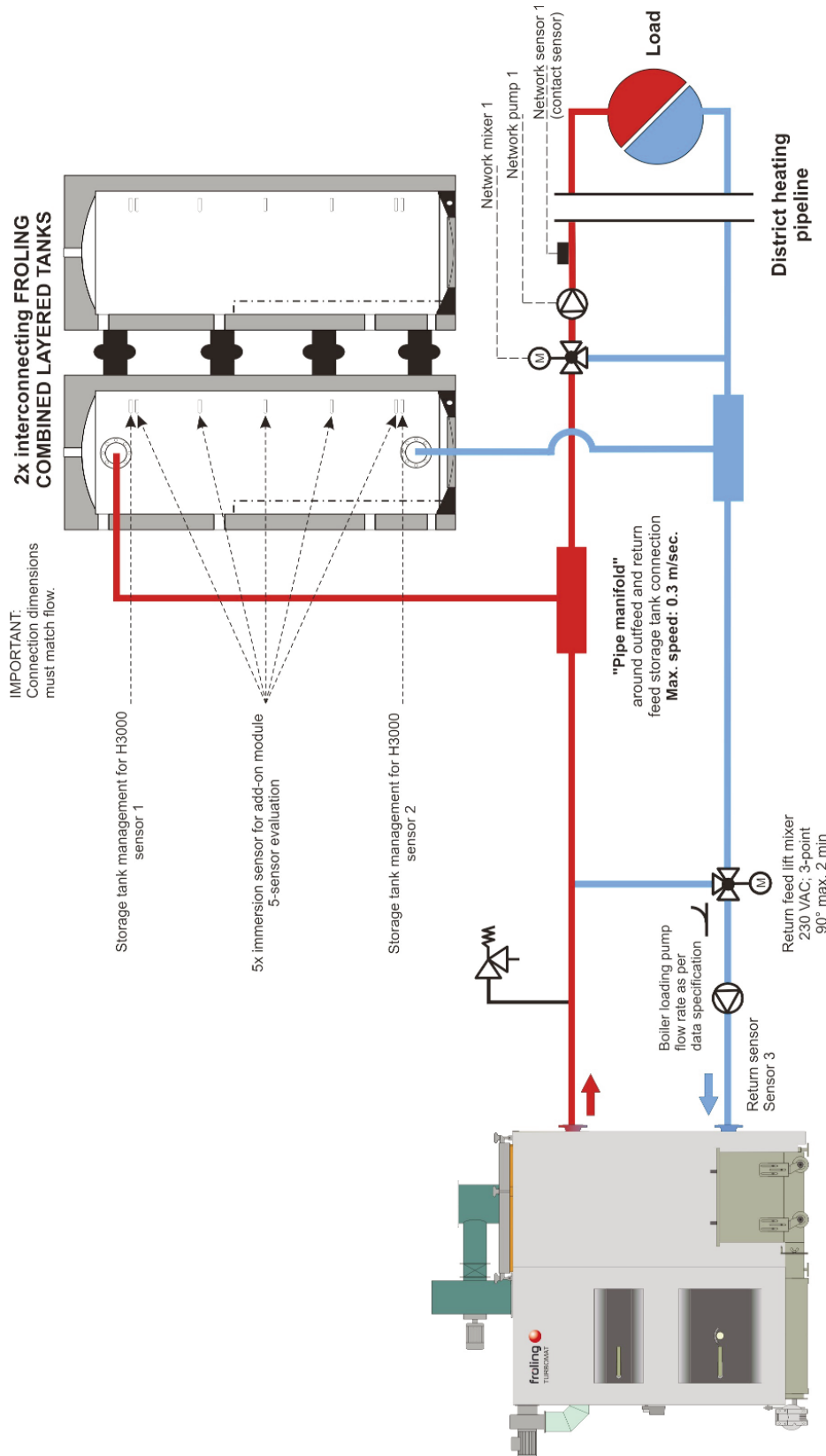



Diagram 2: Turbomat with 2 interconnecting thermal stores

System 2.1



# Recommended hydraulic layouts

Diagram 2: Turbomat with 3 reverse-return thermal stores

System 2.2

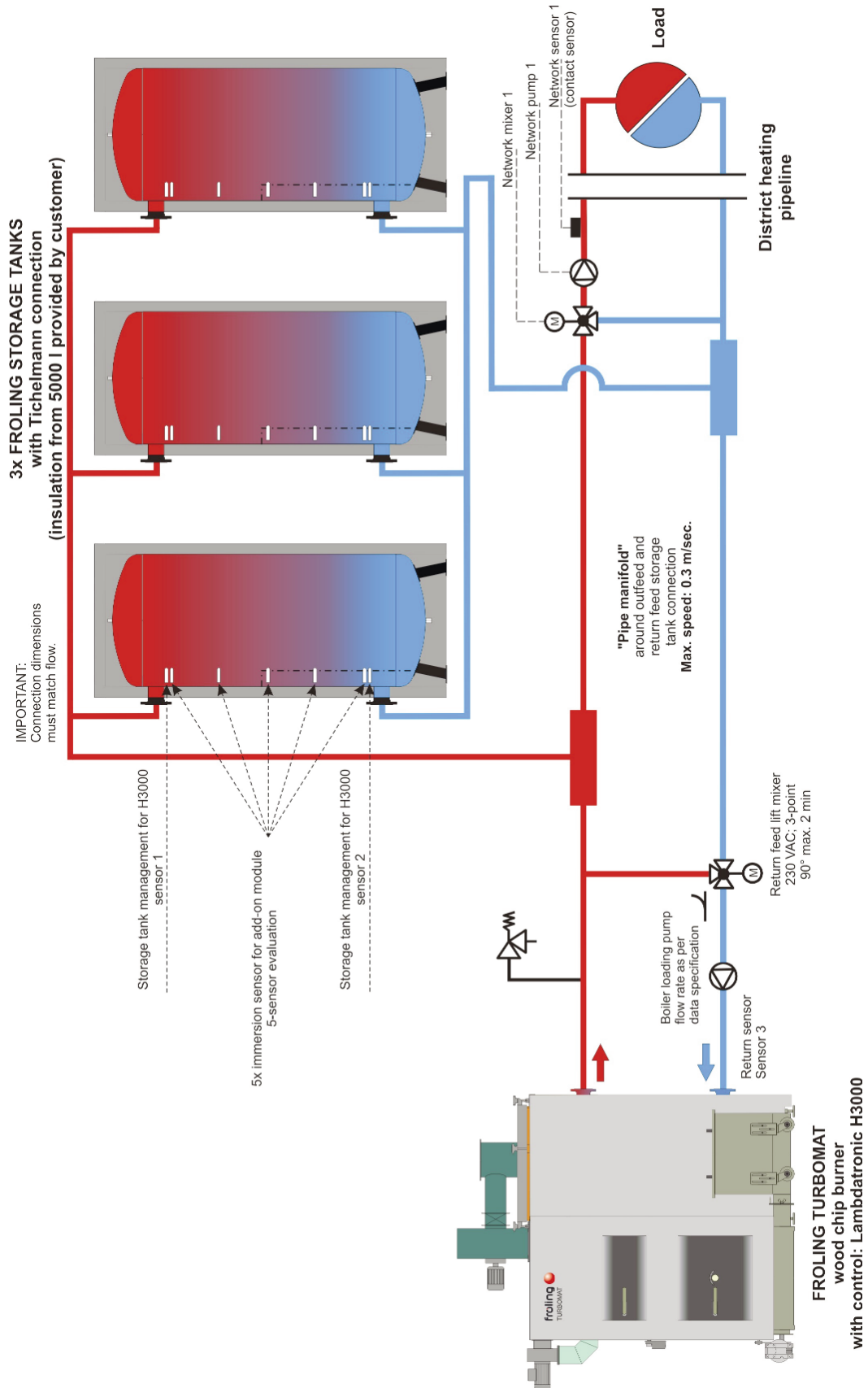
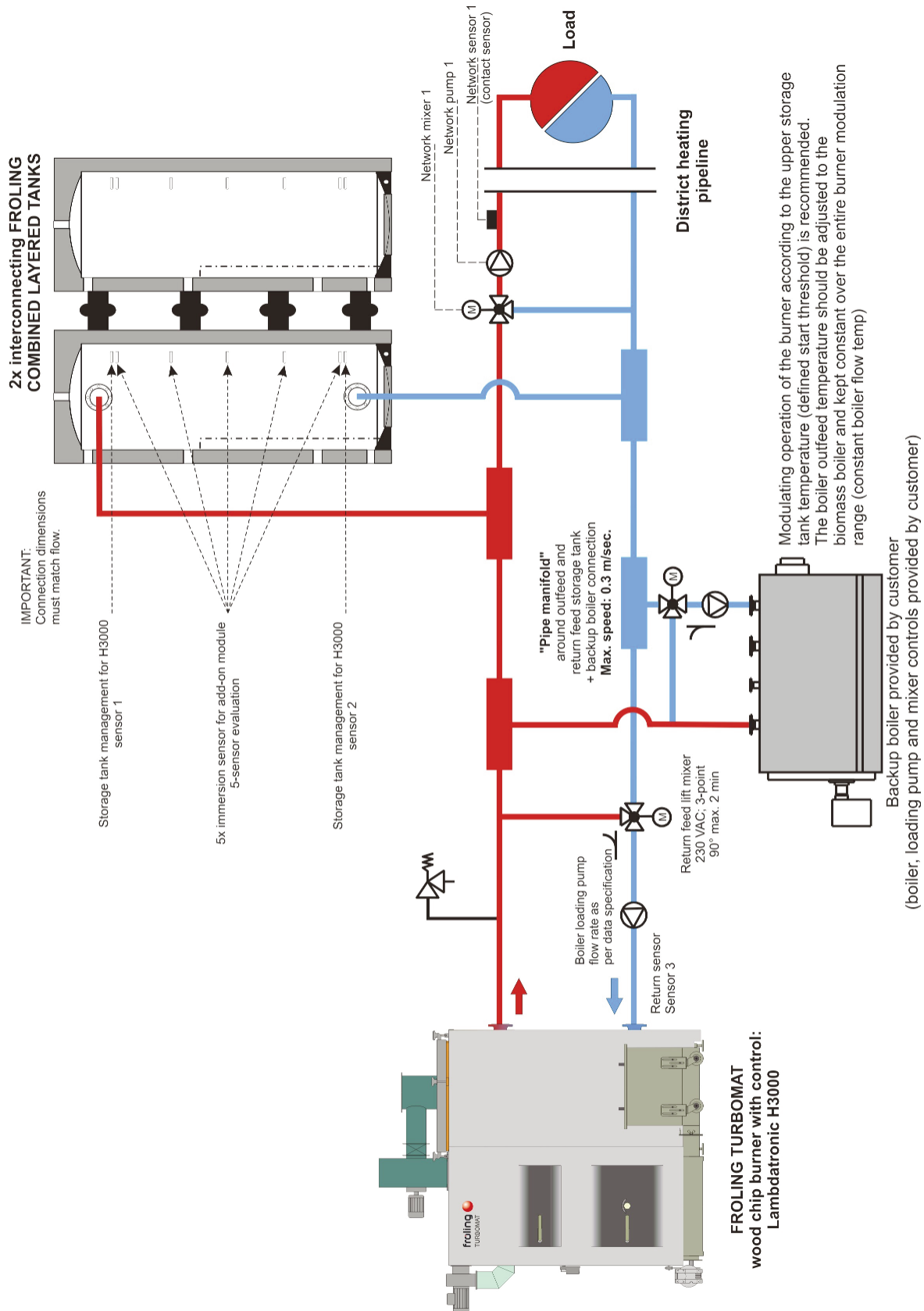

Diagram 2: Turbomat double boiler system with backup boiler and 2 interconnecting thermal stores

System 2.3



# Recommended hydraulic layouts

Diagram 2: Turbomat double boiler system with backup boiler and 3 interconnecting thermal stores

System 2.4

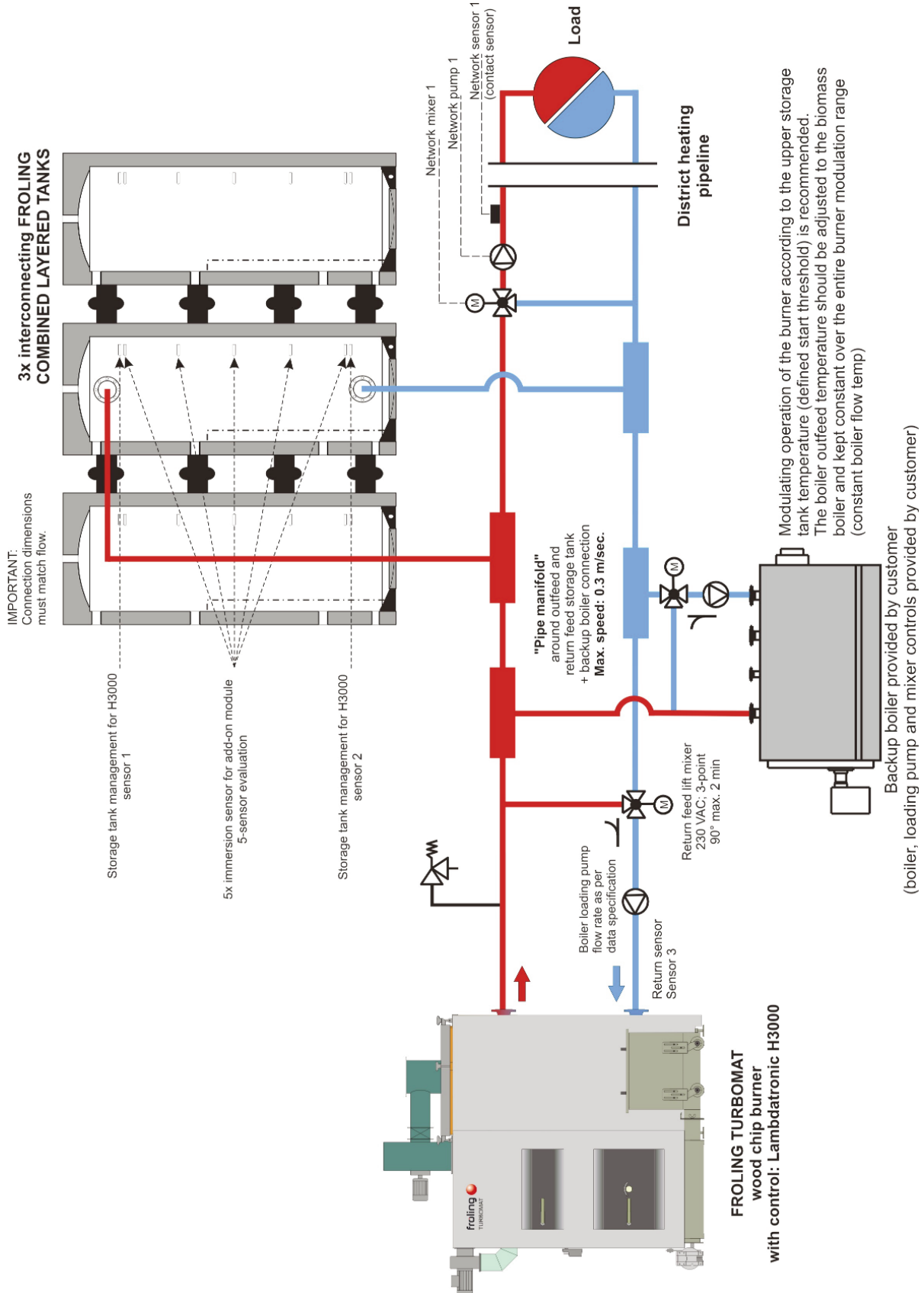
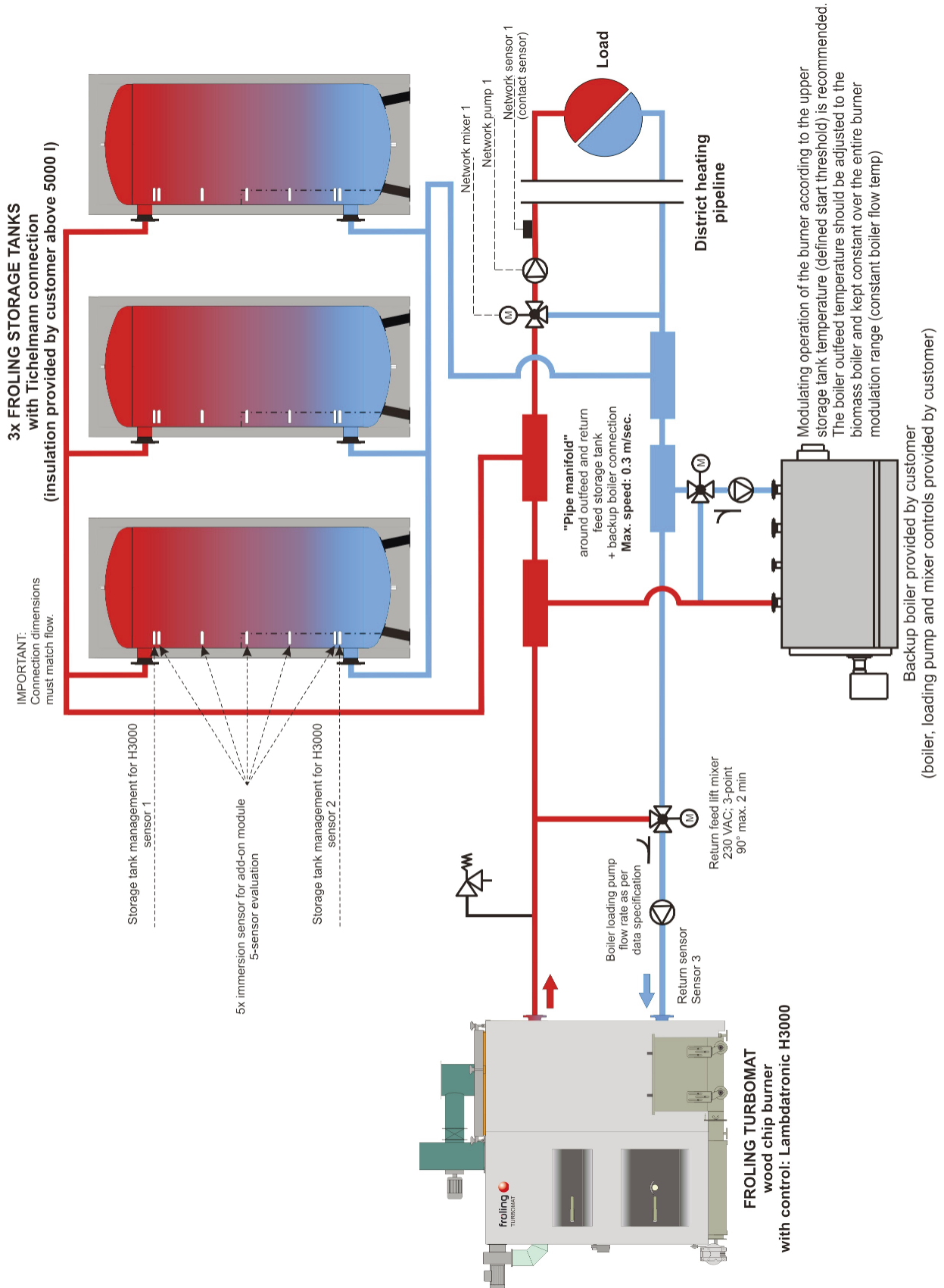

Diagram 2: Turbomat double boiler system with backup boiler and 3 reverse-return thermal stores

System 2.5



# Recommended hydraulic layouts

Diagram 1: Lambdamat with low-loss header and DHW tank

System 1.3

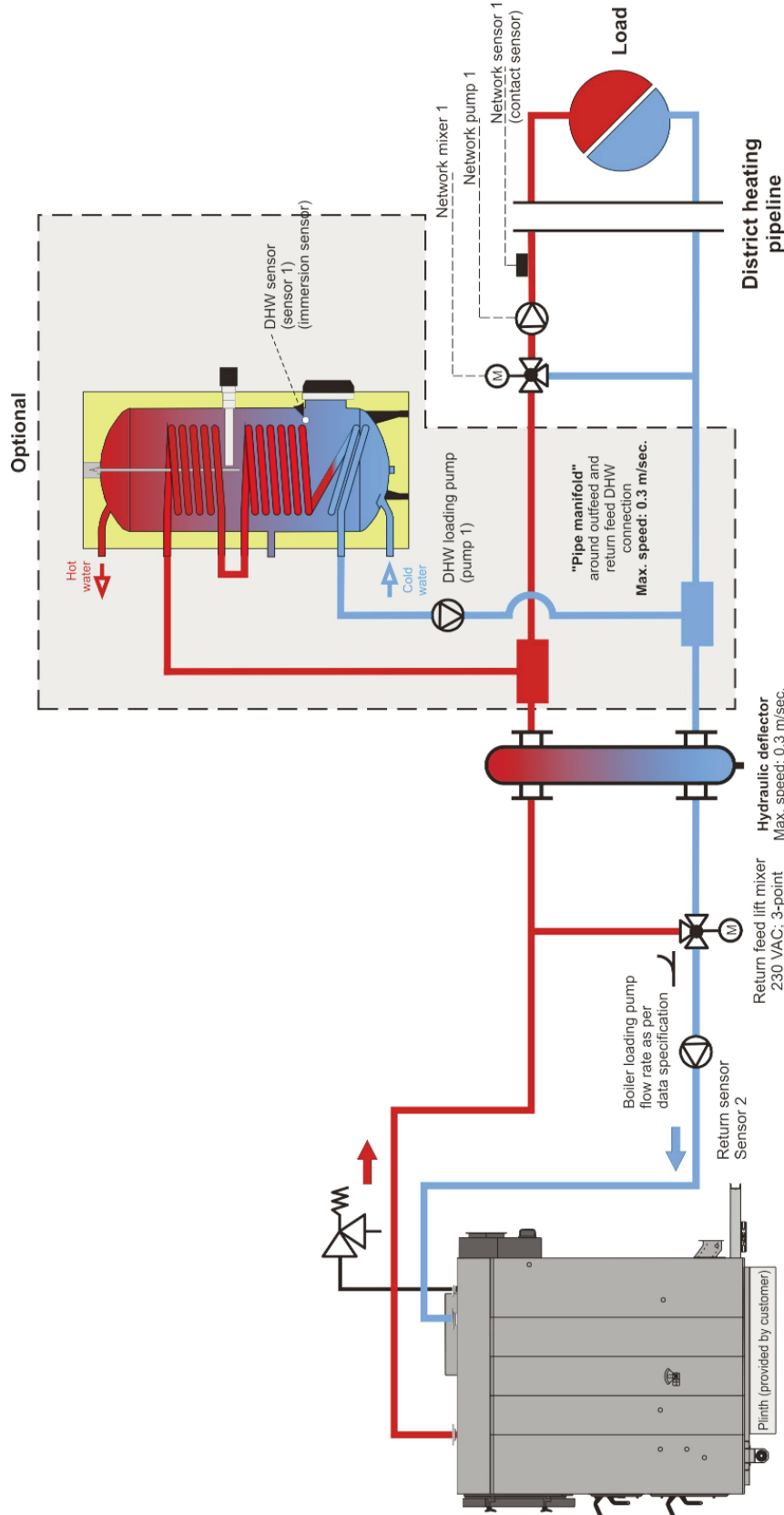

**IMPORTANT:** Using a hydraulic deflector instead of a storage tank requires continuous and constant/slightly variable power consumption!

**FROLING LAMBDAMAT**  
wood chip burner  
with control: Lambdatronic H3000

Diagram 2: Lambdamat with thermal store

System 2.6

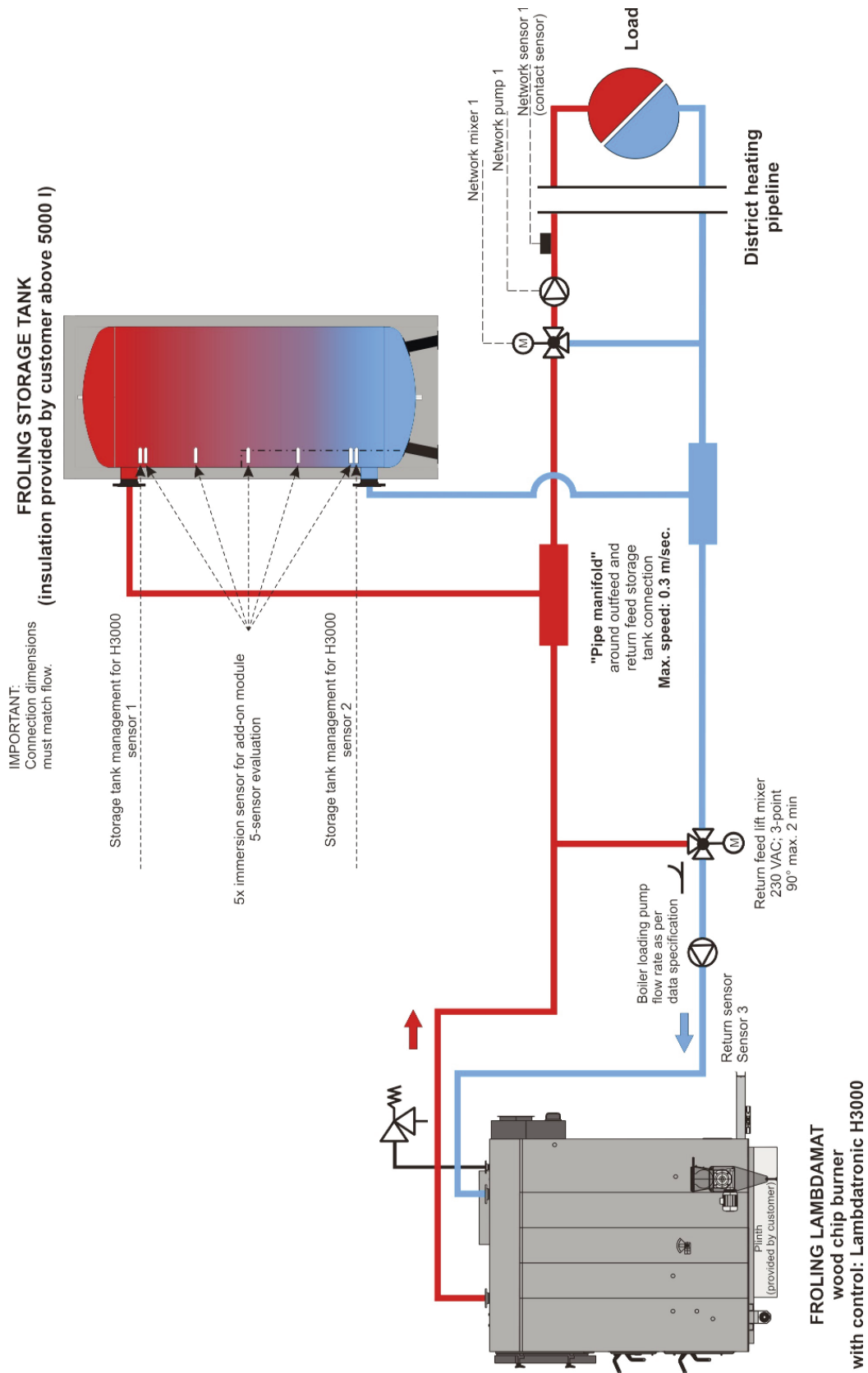

# Europe's number one name in wood heating

P0560111 - We reserve the right to make technical changes without prior notice. Errors and omissions excepted.

DRV 164852 • Commercial Register / 99229a • UID / ATU 22256902  
Place of jurisdiction / Wels District and Commercial Court • ARA Licence 4480

**froeling** 

**Heizkessel- und Behälterbau GesmbH  
A-4710 Grieskirchen, Industriestr. 12**

AUT: Tel +43 (0) 7248 606 • Fax +43 (0) 7248 606-600  
GER: Tel +49 (0) 89 927 926 0 • Fax +49 (0) 89 927 926 219  
Email: [info@froeling.com](mailto:info@froeling.com) • Internet: [www.froeling.com](http://www.froeling.com)